

60" Mulching Kits

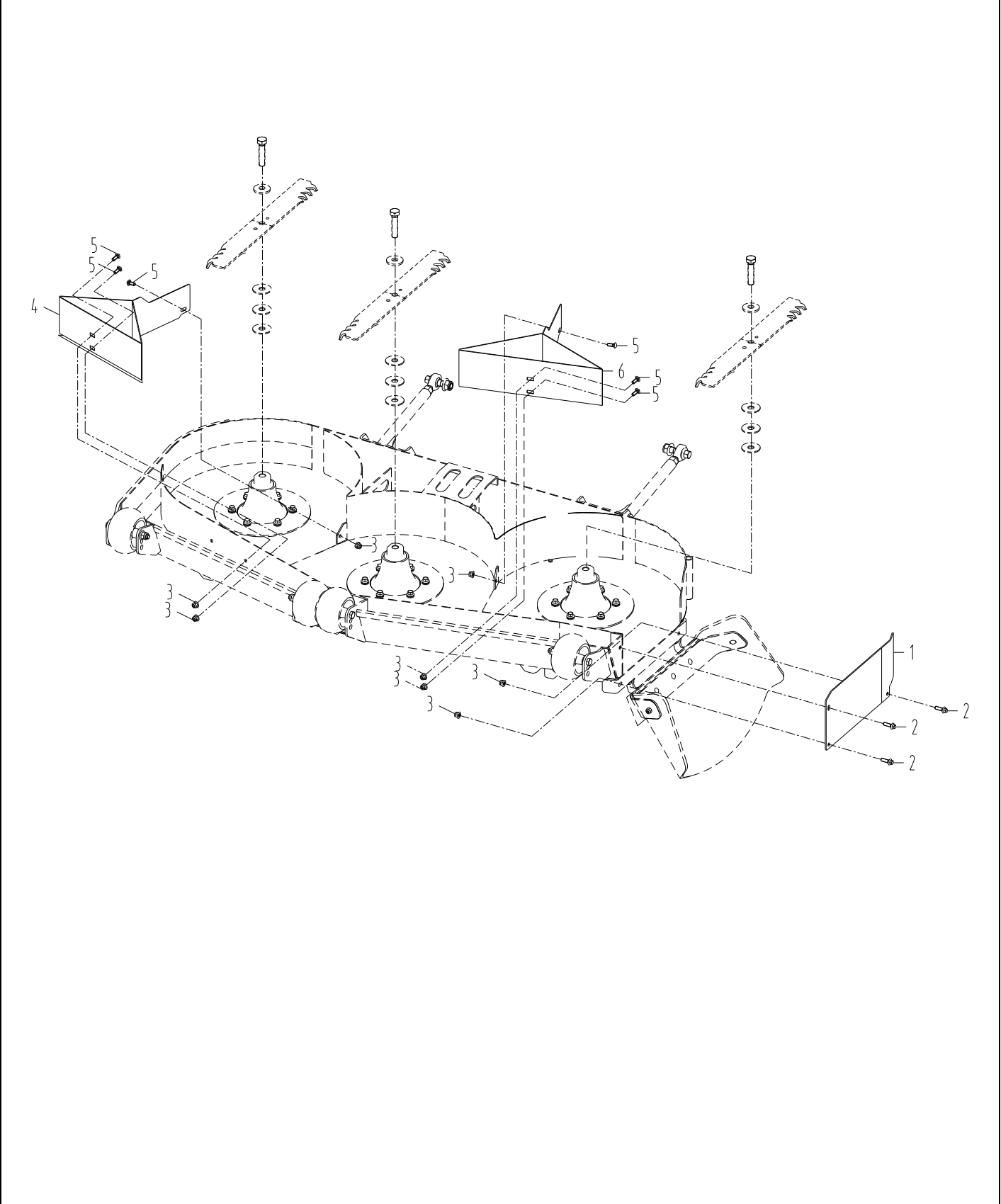

Installation Instructions

60" Mulch Kit, 8260MC

(ERP-7403402)



Step 1 – Verify contents of the mulch kit to prepare for installation.

Step 2 – Remove mower discharge chute and retain for reinstallation as needed.

Step 3 – Remove mower blades (3) and retain hardware for reinstallation.

Step 4 – Install LH mulch baffle using (3) M8x20 carriage bolts and (3) M8 Nylock flanged nut.

Step 5 – Install RH mulch baffle using (3) M8x20 carriage bolts and (3) M8 Nylock flanged nut.

Step 6 – Install mulch skirt using (1) M8x20 carriage bolt with M8 Nylock flanged nut and (3) M8x25 Hex flange bolt with (3) M8 Nylock flanged nut.

Step 7 – Install supplied blades using blade hardware removed in step 3.

